

Perspective View

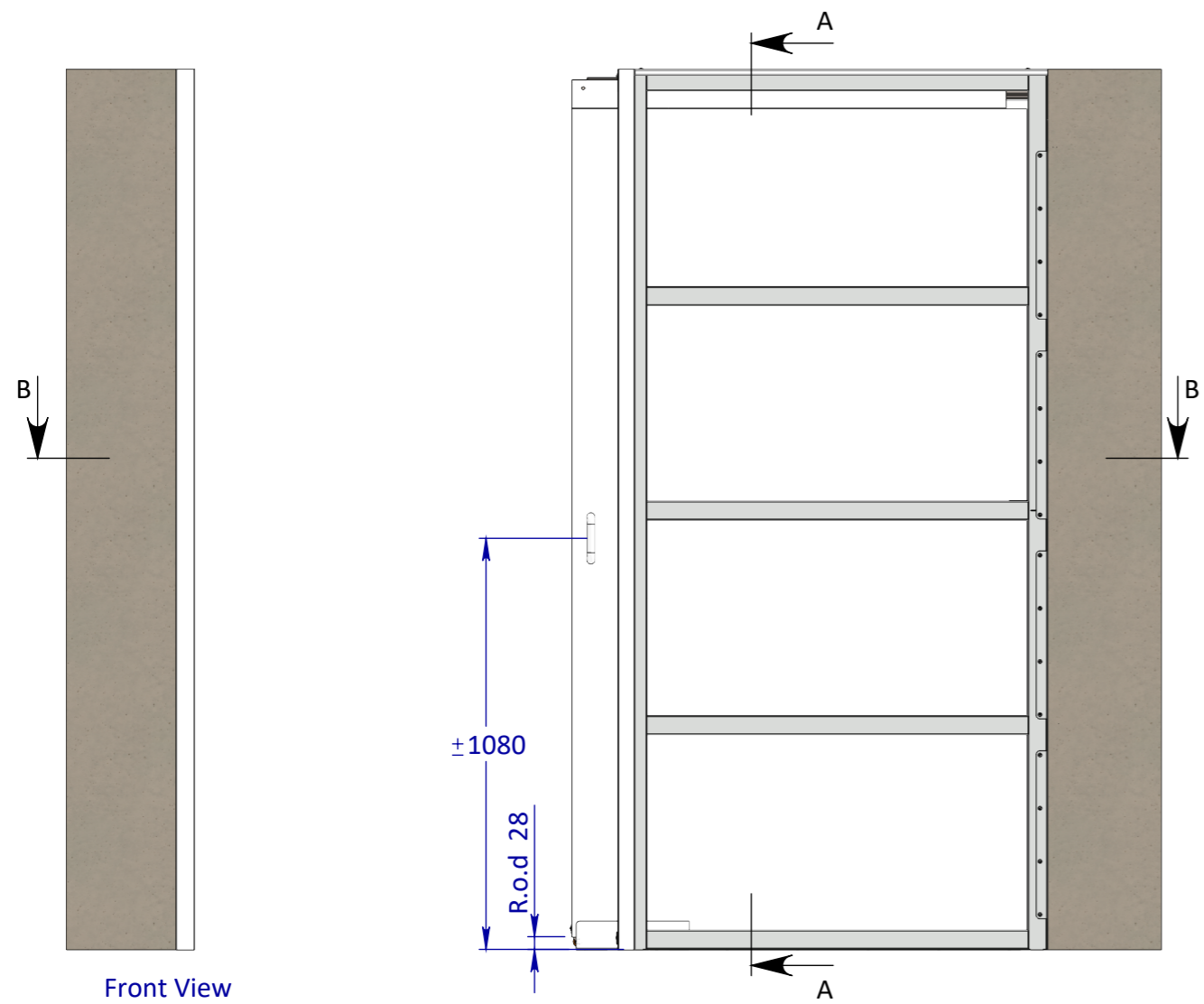

Front View

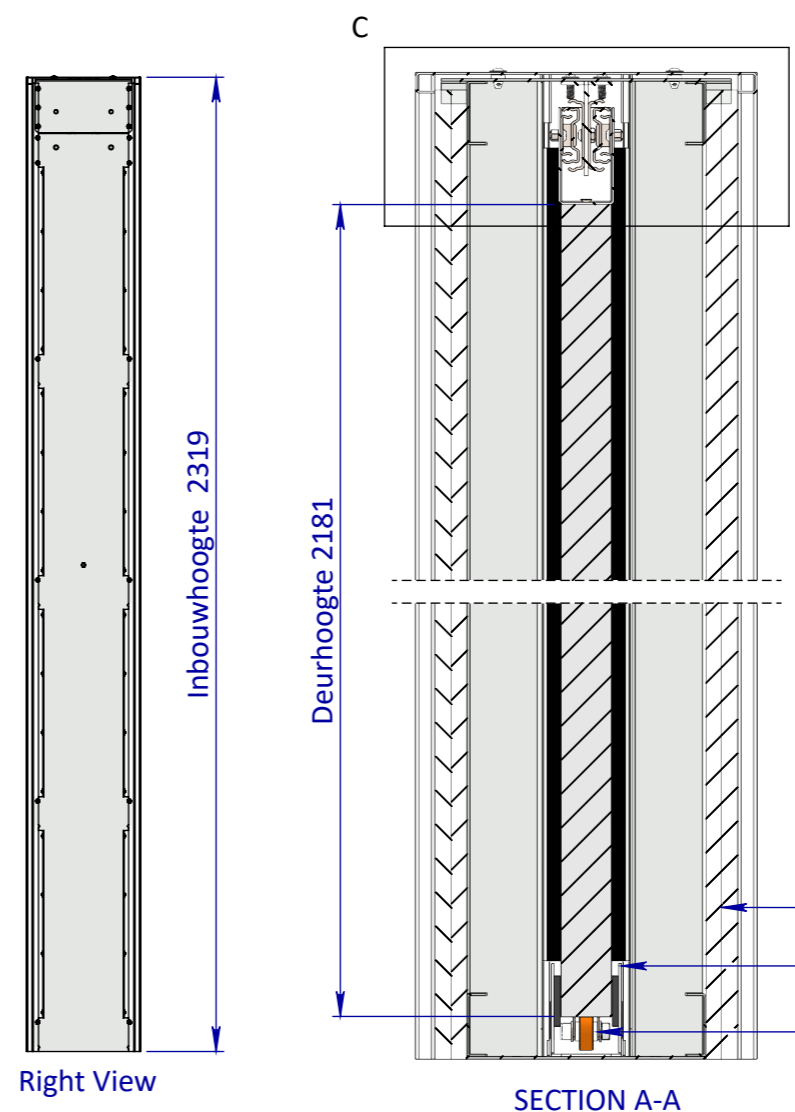

Right View

SECTION A-A

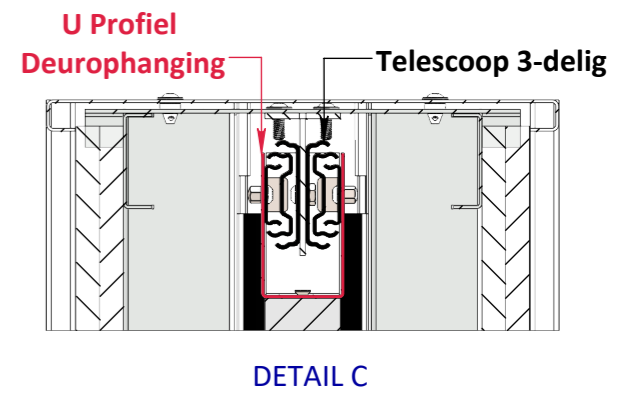

DETAIL C

EIGENDOM BEWAARDEN BIJ SOMEREN. VERMENIGVULDING OF AFDDELING AAN DERDEN IN WELKE VORM DAN OOK IS ZONDER SCHRIFTELIJKE TOESTEMMING VAN EIGENARES NIET GELOOFD.	TOLERANTIES ALGEMEEN. * Herkenningsmaat / mal Maattolerantie ± 0.5 mm Hoektolerantie ± 0.5°	MATERIAAL. Diversen	SCHAAL / MAATEENHEID	
	AMERIKAANSE PROJECTIE A3	BENAMING. Floorfix Assembly 1000 - Assembly 1000	millimeter [mm]	
 VARI-DOORS SCHUIFDEURSYSTEMEN	Revisienr. Omschrijving	Datum	Naam	TEKENINGNUMMER
	07 Revisie diversen onderdelen	8-7-2025	JBEL	AL001-1200-07
06 Hoogte en revisie diversen	7-10-2024	JBEL	REF. AL001-1200-07	

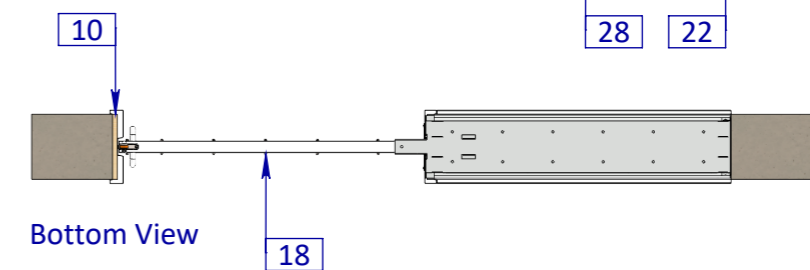
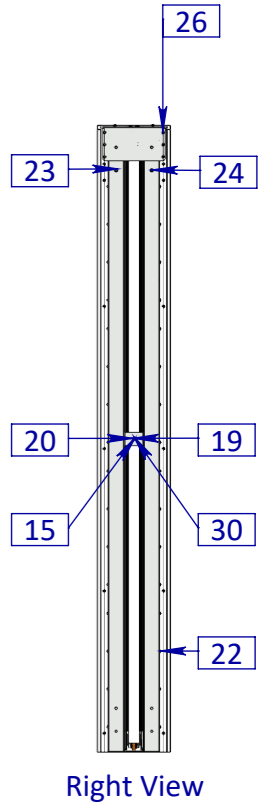
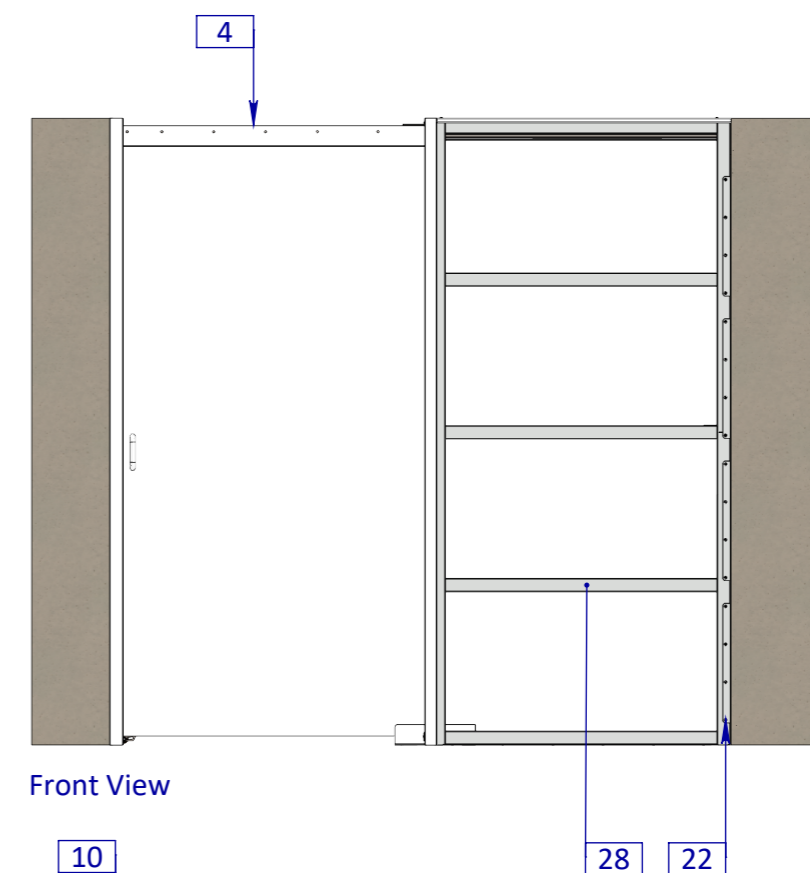
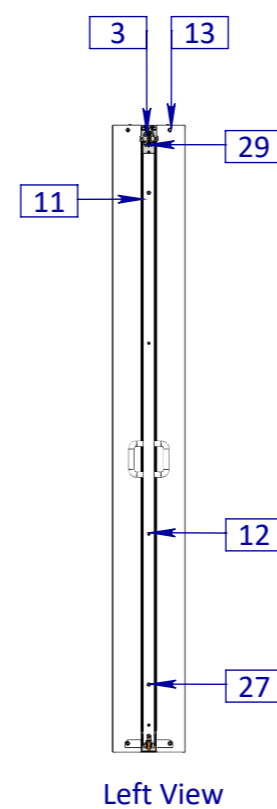
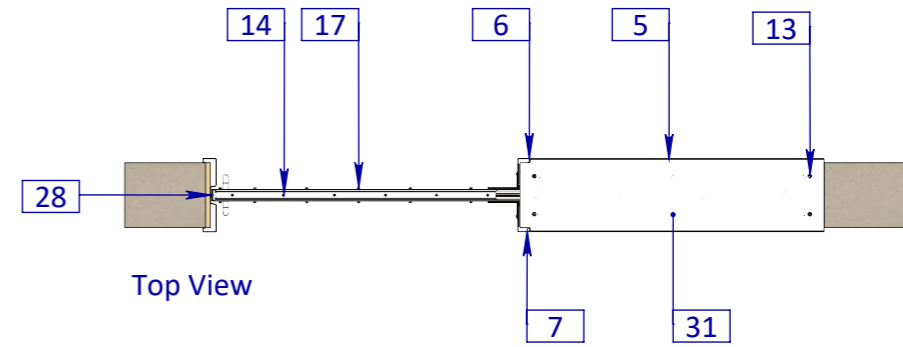
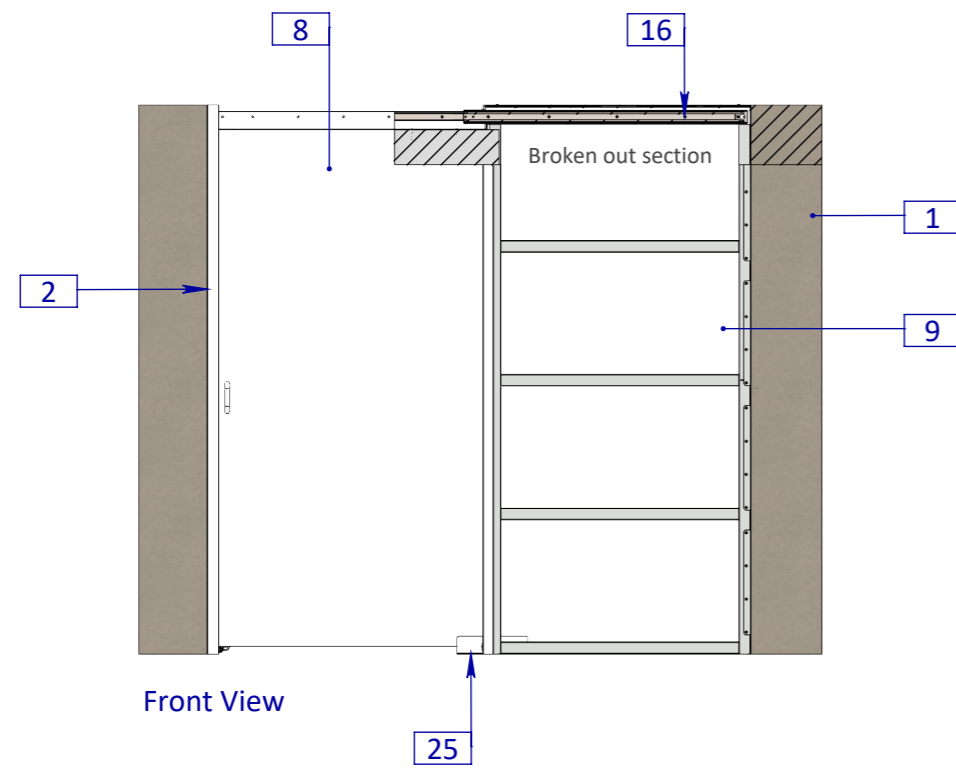

Posnr.	Aantal	Omschrijving	Tekeningnr	Config.Omschr.
1	1	Wand	AL001-2000-02	Floorfix 1000
2	1	Floorfix Sluitstijl Config	AL001-1000-03	L=2319mm
3	2	Telescoop ladegeleider	AL001-2400-00	L=1200mm
4	1	U profiel Deurophanging	AL001-1220-00	telescope 1200mm db 1100mm
5	1	Deksel Finish	AL001-1121-02	tbv assembly 900
6	1	Verticale Afwerklijst	AL001-1122-05	Links
7	1	Verticale Afwerklijst	AL001-1122-05	Rechts
8	1	Deur Assembly	AL001-2500-02	Deurbreedte 1200mm
9	4	Gipsplaat 12.5mm Dik		1100mm
10	1	Lat 18mm config.		L=2319mm
11	2	Borstel Standaard		L=2181mm Enkelzijdig
12	4	M4.2x13 Panhead flange		DIN 968
13	16	M6x16 Panhead Flange		ISO 7380-2
14	6	M4.5x50 Tapping screw		DIN7997
15	1	Deurbuffer 46mm		L=46mm
16	5	M5 Hexagon Thin Nut		DIN 439B
17	12	M5 x 8 Socket Button head screw		ISO 7380-1
18	12	M5 Hexagon Cup Nut		DIN 917-50
19	1	M6 Hexagon Nut		ISO 4032
20	1	M6.4 x 12 Washer		ISO 7089
21	5	M5 x 10 Socket Button head screw		ISO 7380-1
22	32	M4 x 12 Panhead Flange		DIN 967
23	2	Blindklinkmoer M6		
24	2	M6 x 40 Hex bolt		ISO 4016
25	1	Ondergeleiding	AL001-2100-05	
26	18	Slagplug met schroef		
27	2	Stootdopje		Stootdopje zelfklevend
28	1	Nisframe compleet gelast	AL001-1210-05	Compleet Nisframe 1000mm
29	1	Ophanging telescoop gelast 900 / 1000	AL001-1130-00	Floorfix 900 / 1000
30	1	M6 x 30 Hex head socket screw		DIN 912
31	6	Bufferdopje 3.5mm	AL029-002-00	Kleur Wit / Zwart

EGENDOM BUREAU BY SOMEREN
VERNIEUWING OF AFWERKING
AAN DEUREN IN WELKE VORMDAN OOK
IS ZONDER SCHRIFTELIJKE TOESTEMMING
VAN GEWENSBARE NIET GEORLOOFT.

TOLERANTIES ALGEMEEN.
* Herkenningsmaal / mal
Maattolerantie ± 0.5 mm
Hoektolerantie ± 0.5°

MATERIAAL. Diversen

SCHAAL / MAATEENHEID
millimeter [mm]

BENAMING.
Floorfix Assembly 1000
- Assembly 1000

TEKENAAR / DATUM
John Belemans
11-1-2023

AMERIKAANSE PROJECTIE
 A3

TEKENINGNUMMER
AL001-1200-07

Revisienr. Omschrijving

Datum

Naam

TEKENINGNUMMER

07 Revisie diversen onderdelen

8-7-2025

JBEL

AL001-1200-07

06 Hoogte en revisie diversen

7-10-2024

JBEL

REF. AL001-1200-07

Varidoors

